



RT35 | Rough Terrain Crane 35 t Lifting Capacity



METRIC

RT35

ROUGH TERRAIN CRANE

CONTENTS · INDICE

	Page · Pagina:
Key · Legenda	
.....	3
Dimensions · Dimensioni	
Crane dimensions · Dimensioni gru	5
Transport dimensions · Dimensioni in assetto da trasporto	5
Crane weights · Peso della gru	6
Steering radii · Raggi di sterzata	7
Load charts · Diagrammi di carico	
Range graph main boom · Campo di portata braccio base	8
Load chart main boom · Diagramma di carico braccio base	9
Range graph lattice type jib · Campo di portata prolunga tralicciata	10
Load chart lattice type jib · Diagramma di carico prolunga tralicciata	11
Range graph box type jib · Campo di portata prolunga scatolata	12
Load chart box type jib · Diagramma di carico prolunga scatolata	13
Load chart pick & carry · Diagramma di carico „pick & carry“	14
Technical description · Descrizione tecnica	
Boom · Braccio	15
Winch, rope and hook · Argano, fune e gancio	15, 16
Superstructure · Sovrastruttura	16
Cab, controls and safety devices · Cabina, comandi ed equipaggiamento di sicurezza	16
Carrier, engine, drive-line and hydraulic · Carro, motore, trasmissione e sistema idraulico	17
Vehicle performance · Prestazioni del veicolo	17
Tires · Pneumatici	18
Other options · Altre opzioni	18

KEY · LEGENDA

	Counterweight Contrappeso		General performance Prestazioni generali
	Main boom Braccio base		Telescoping mode Modalità di sfilo
	Boom length Lunghezza braccio		Boom elevation angle Angolo di brandeggio
	Tip height Altezza testa braccio		Working radius Raggio di lavoro
	Boom with extension Braccio con prolunga		Max. boom length with extension Lunghezza braccio max. con prolunga
	Main boom with aux head Braccio base con testa ausiliaria		Distance from the hook to the head sheave axle Distanza dal gancio all'asse puleggia in testa
	Slewing / Allowable slewing range Rotazione / Intervallo di rotazione consentito		Slewing locked / Slewing locked at specified position Blocco rotazione / Blocco rotazione su una posizione specifica
	Slewing brake Freno rotazione		Slewing gears Meccanismo di rotazione
	Outriggers / Lifting on outriggers (100/50/0% extended) Stabilizzatori / Portate su stabilizzatori (100/50/0% di apertura)		Lifting on wheels / Pick & Carry Portate su ruote / „pick & carry“
	Main winch Argano principale		Auxiliary winch Argano ausiliario
	Winch speed Velocità dell'argano		Rope length Lunghezza fune
	Rope - Standard / Optional Fune - standard / opzionale		Max. line pull Tiro max.
	Rope diameter Diametro fune		Tires Pneumatici
	Hook block Bozello		Controls Comandi
	Cab Cabina		Engine Motore
	Load limiter / Load indicator Limitatore di carico / Indicatore di carico		Steering Sterzo
	Mechanical transmission Trasmissione meccanica		Speed Velocità
	Hydraulics Sistema idraulico		Heating / Air conditioning Riscaldamento / Aria condizionata
	Working temperature Temperatura di esercizio		Gradeability Pendenza superabile
	Lights Luci		Gross vehicle weight Peso lordo del veicolo
	Crane / Crane in standard configuration Gru / Gru in configurazione standard		Weight on front axle Peso sull'assale anteriore
	Crane without counterweight Gru senza contrappeso		Weight on rear axle Peso sull'assale posteriore

RT35**HIGHLIGHTS**

- Capacity at rated distance:
35 t at 3 m from center of rotation
- Maximum main boom length:
30.1 m
- Maximum main boom with extension tip height:
40.5 m

- Capacità nominale:
35 t a 3 m dal centro di rotazione
- Lunghezza massima braccio telescopico:
30.1 m
- Massima altezza testa braccio telescopico con prolunga:
40.5 m

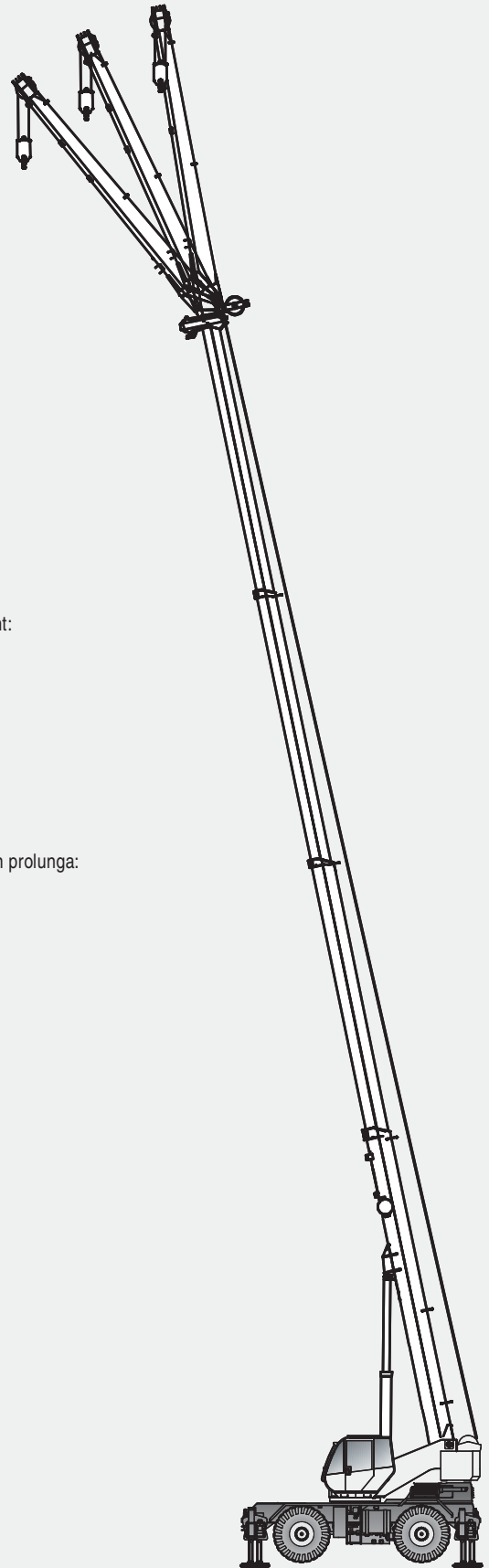

CRANE DIMENSIONS · DIMENSIONI GRU

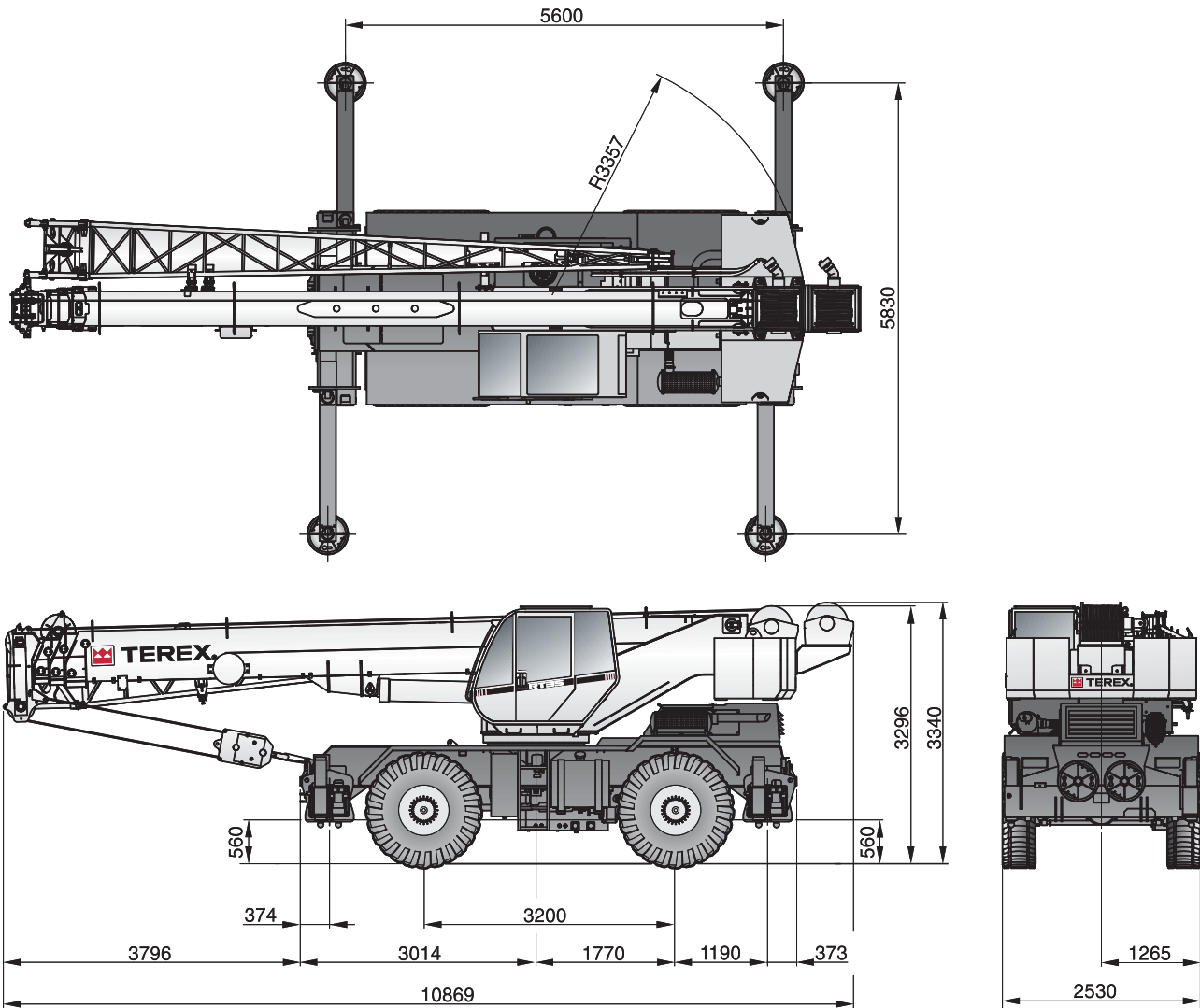



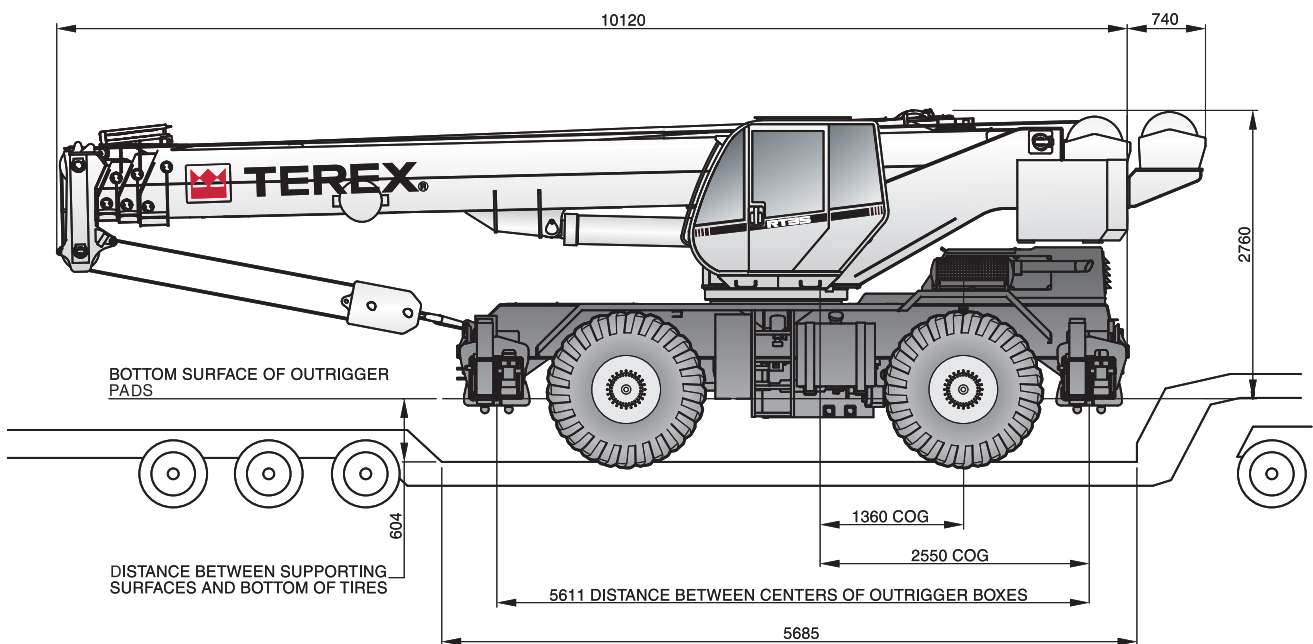



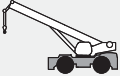

TRANSPORT DIMENSIONS · DIMENSIONI IN ASSETTO DA TRASPORTO



CRANE WEIGHTS · PESO DELLA GRU
WEIGHTS · PESO

		↓ GVW	↑	↑
	STD (without hook block and auxiliary winch) STD (senza bozzello e argano ausiliario)	24450 kg	11300 kg	13150 kg

Adds for optional equipment
Da aggiungere a seconda dell'allestimento opzionale

	8 mt box type jib stowed aside the boom 8 mt prolunga scatolata staffata a lato braccio	+ 400	+ 466	- 66
	8 mt lattice type jib stowed aside the boom 8 mt prolunga tralicciata staffata a lato braccio	+ 350	+ 408	- 58
	Main boom with aux head Braccio principale con testa ausiliaria	+ 85	+ 280	- 195
	2 Auxiliary winch TW4** Argano ausiliario TW4**	+ 605	- 431	+ 1036
	4 sheaves, 30 tons* 4 pulegge, 30 tons*	+ 250	+ 400	- 150
	4 sheaves, 30 tons*, rams horn 4 pulegge, 30 tons*, ad ancora	+ 280	+ 450	- 170
	3 sheaves, 20 tons* 3 pulegge, 20 tons*	+ 260	+ 418	- 158
	1 sheave, 10 tons* 1 puleggia, 10 tons*	+ 170	+ 273	- 103
	1 sheave, 5 tons* 1 puleggia, 5 tons*	+ 50	+ 80	- 30

NOTE: Values are subject to 2% variation · NOTA: I valori possono variare fino al 2%

* Weight distribution calculated considering the hook block linked to the front shield of the machine
Le distribuzioni dei pesi sono calcolate considerando il bozzello legato davanti al carro

** Weight includes rope + winch support
I pesi includono la fune ed i supporti dell'argano

STEERING RADII · RAGGI DI STERZATA

TWO WHEEL STEER · STERZATA A DUE RUOTE

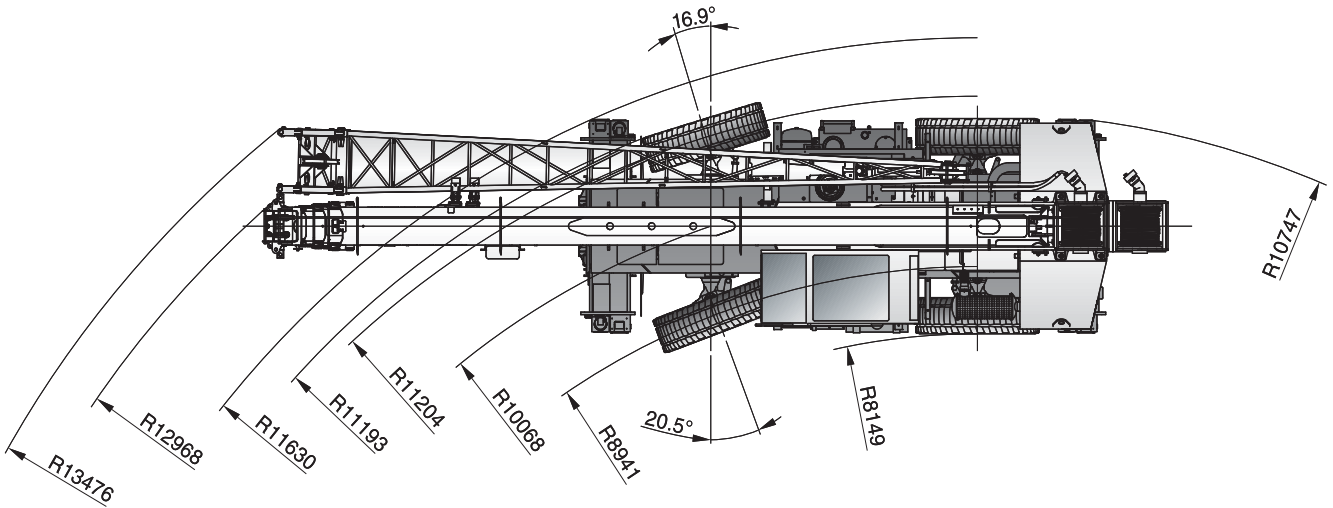

FOUR WHEEL STEER · STERZATA A QUATTRO RUOTE

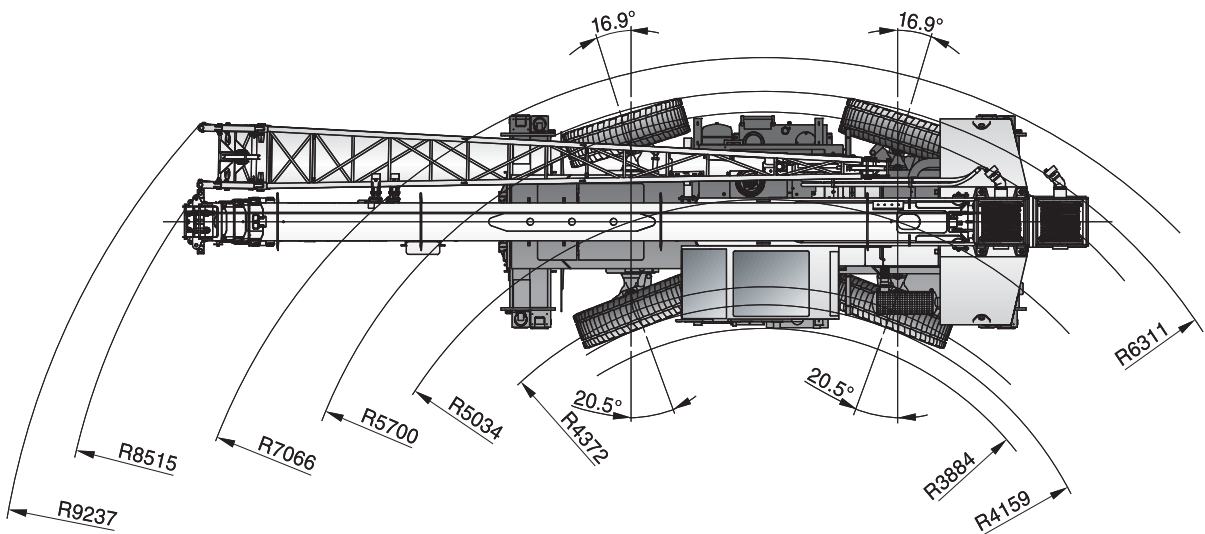

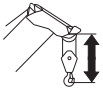

with hook ball: 0,7 m
with hook block: 1,6 m

con gancio a palla: 0,7 m
con bozzello: 1,6 m

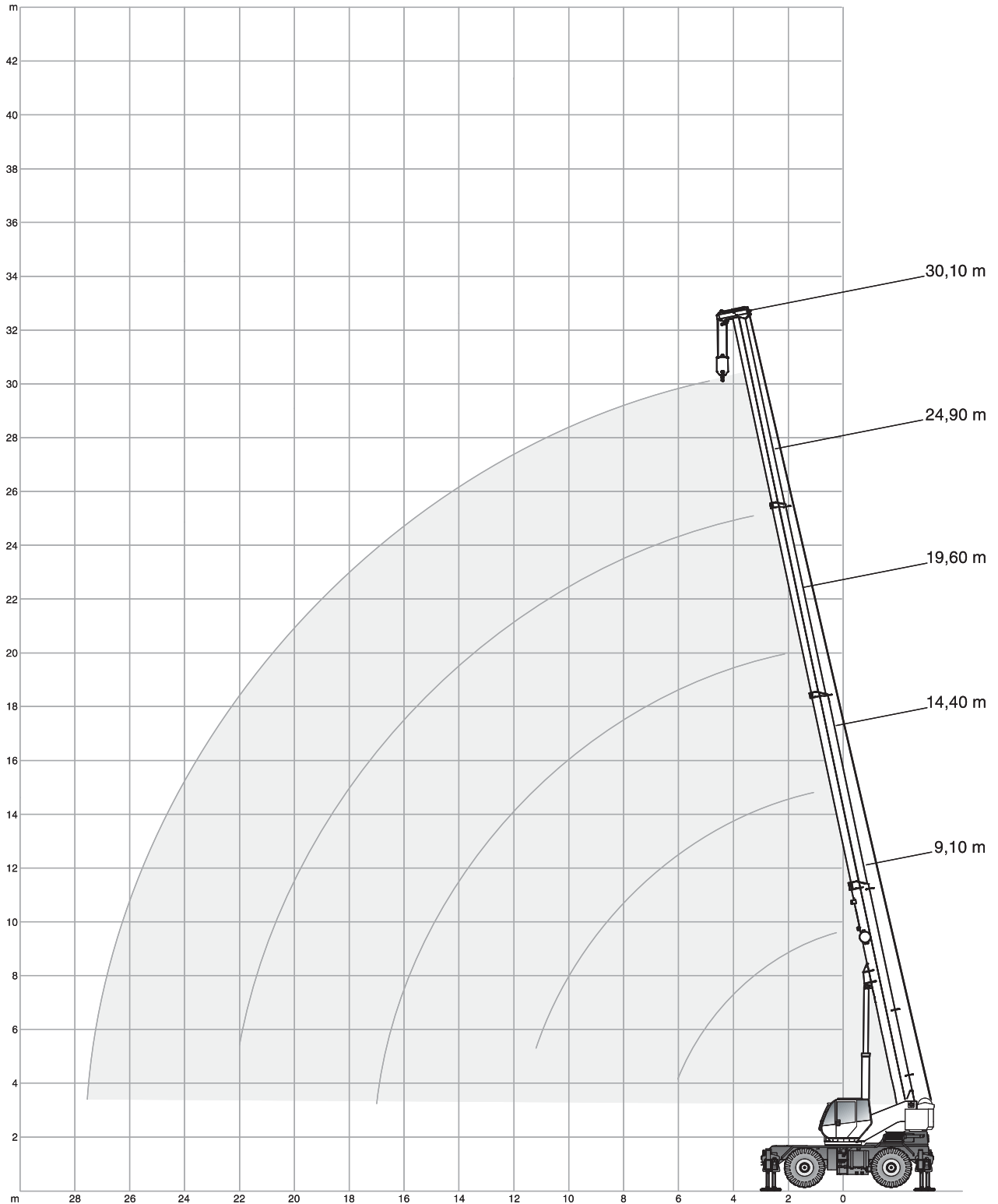



5 t		5,6 m x 5,8 m		360°		EU STANDARD EN 13 000	
		9,1 m	14,4 m	19,6 m	24,9 m	30,1 m	
m	t	t	t	t	t	t	m
3	35,00	21,70	16,10	-	-	-	3
3,5	31,00	20,75	15,00	12,90	-	-	3,5
4	28,40	19,90	14,05	12,05	-	-	4
4,5	25,50	19,15	13,20	11,30	5,00	-	4,5
5	23,00	18,45	12,45	10,60	5,00	-	5
6	16,25	17,25	11,00	9,40	5,00	-	6
7	-	12,10	9,80	8,35	5,00	-	7
8	-	9,45	8,85	7,50	5,00	-	8
9	-	7,60	8,05	6,80	5,00	-	9
10	-	6,25	6,30	6,20	5,00	-	10
11	-	5,25	5,30	5,70	4,80	-	11
12	-	-	4,50	4,50	4,50	-	12
13	-	-	3,85	3,80	3,70	-	13
14	-	-	3,30	3,30	3,30	-	14
15	-	-	2,90	2,85	2,85	-	15
16	-	-	2,45	2,50	2,50	-	16
17	-	-	2,15	2,15	2,20	-	17
18	-	-	-	1,90	1,90	-	18
19	-	-	-	1,65	1,65	-	19
20	-	-	-	1,40	1,45	-	20
21	-	-	-	1,20	1,25	-	21
22	-	-	-	1,05	1,05	-	22
23	-	-	-	-	0,90	-	23
24	-	-	-	-	0,75	-	24
25	-	-	-	-	0,65	-	25
26	-	-	-	-	0,50	-	26
27	-	-	-	-	0,40	-	27

5 t		5,6 m x 3,3 m		360°		EU STANDARD EN 13 000	
		9,1 m	14,4 m	19,6 m	24,9 m	30,1 m	
m	t	t	t	t	t	t	m
3	30,90	21,70	16,10	-	-	-	3
3,5	21,95	20,75	15,00	12,90	-	-	3,5
4	16,90	17,05	14,05	12,05	-	-	4
4,5	13,45	13,55	13,20	11,30	5,00	-	4,5
5	11,10	11,20	12,45	10,60	5,00	-	5
6	8,05	8,15	8,15	8,20	5,00	-	6
7	-	6,20	6,25	6,25	5,00	-	7
8	-	4,90	4,90	4,95	4,95	-	8
9	-	3,95	3,95	3,95	3,95	-	9
10	-	3,20	3,25	3,25	3,25	-	10
11	-	2,60	2,65	2,65	2,65	-	11
12	-	-	2,15	2,15	2,15	-	12
13	-	-	1,80	1,80	1,80	-	13
14	-	-	1,45	1,45	1,45	-	14
15	-	-	1,20	1,20	1,20	-	15
16	-	-	0,95	0,95	0,95	-	16
17	-	-	0,75	0,75	0,80	-	17
18	-	-	-	0,60	0,60	-	18
19	-	-	-	0,40	0,45	-	19
20	-	-	-	0,30	0,30	-	20

NOTES TO LIFTING CAPACITY · ANNOTAZIONI SULLE PORTATE

Weight of hook blocks and slings is considered part of the load and must be subtracted from the capacity ratings. Consult operation manual for further details.

Note: Data published herein is intended as a guideline only and shall not be construed to warrant applicability for lifting purposes.

For actual crane operation refer to the computer charts and the operating manual, both of which are supplied with the crane.

Il peso dei bozzelli e delle funi di imbracaggio viene considerato parte del carico e deve quindi essere sottratto dalle portate nominali. Per ulteriori dettagli sulla velocità del vento, consultare il manuale di istruzione della gru.

Nota: I dati riportati in questo prospetto sono forniti esclusivamente a titolo indicativo, pertanto non sono da ritenersi impegnativi ai fini dell'applicazione della garanzia sulle portate di sollevamento. Per l'uso della gru occorre rispettare le tabelle originali e il manuale d'uso forniti in dotazione con la gru stessa.

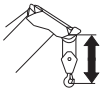
LATTICE TYPE JIB · PROLUNGA TRALICCIATA

with hook ball: 0,7 m
with hook block: 1,6 m

con gancio a palla: 0,7 m
con bozzello: 1,6 m

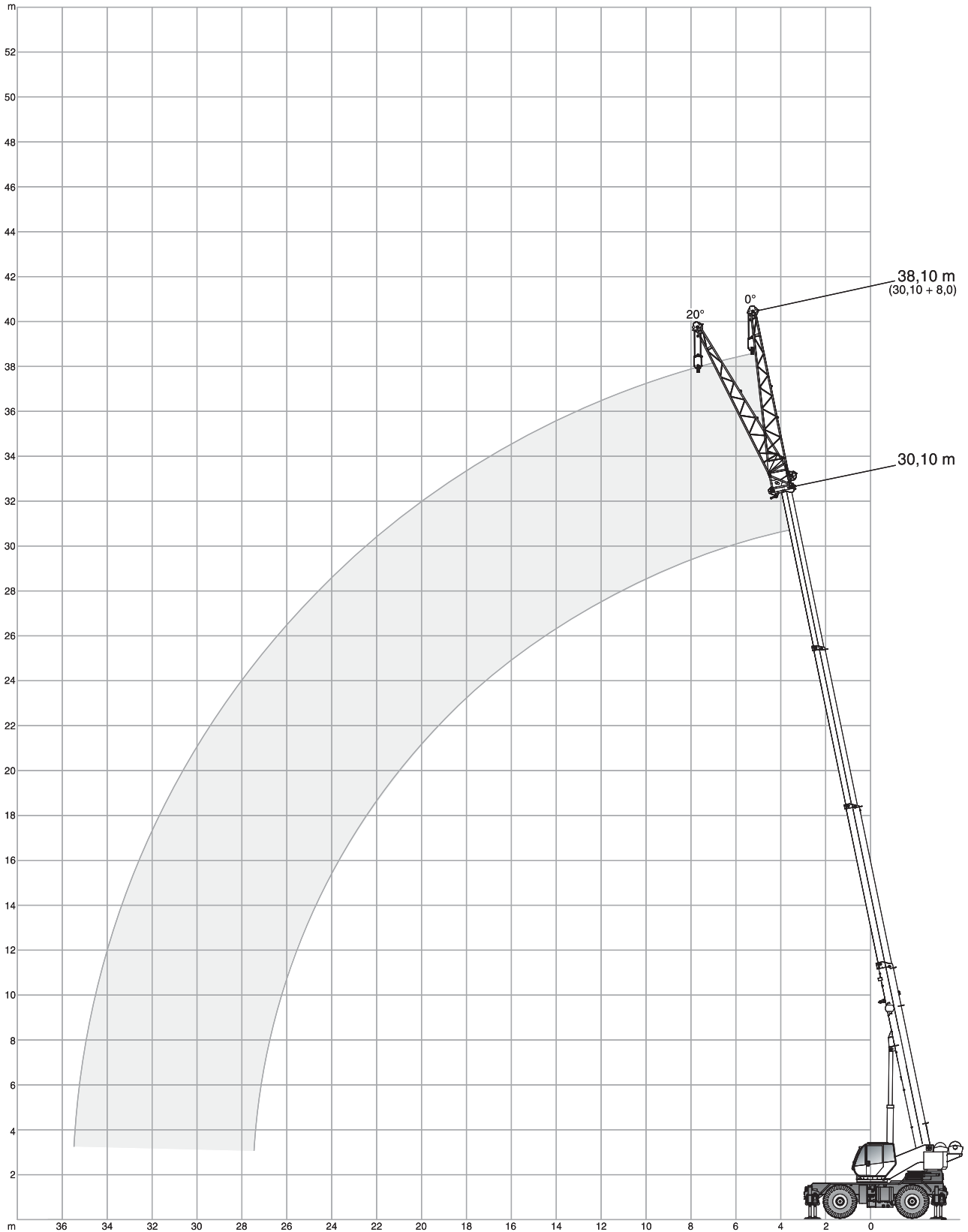

LATTICE TYPE JIB · PROLUNGA TRALICCIATA
 **5 t**
 **5,6 m x 5,8 m**
 **360°**
EU STANDARD EN 13 000

8 m 0°							8 m 20°						
	9,1 m		14,4 m	19,6 m	24,9 m	30,1 m		9,1 m		14,4 m	19,6 m	24,9 m	30,1 m
m	t	t	t	t	t	t	m	t	t	t	t	t	t
3	6,00	6,00	-	-	-	-	3	-	-	-	-	-	-
3,5	5,50	5,50	6,90	-	-	-	3,5	-	-	-	-	-	-
4	5,20	5,20	6,50	-	-	-	4	3,30	-	-	-	-	-
4,5	4,90	4,90	6,10	6,00	-	-	4,5	3,20	-	-	-	-	-
5	4,70	4,70	5,80	5,70	-	-	5	3,10	3,50	-	-	-	-
6	4,30	4,30	5,20	5,10	3,00	-	6	2,90	3,40	3,50	-	-	-
7	4,00	4,00	4,60	4,50	3,00	-	7	2,75	3,20	3,40	3,40	-	-
8	3,65	3,65	4,10	4,00	3,00	-	8	2,65	3,00	3,30	3,30	-	-
9	3,25	3,35	3,75	3,65	3,00	-	9	2,55	2,80	3,20	3,15	2,10	-
10	3,00	3,10	3,50	3,40	3,00	-	10	2,45	2,65	3,00	3,00	2,10	-
11	2,70	2,85	3,25	3,15	3,00	-	11	2,30	2,50	2,85	2,85	2,10	-
12	2,40	2,70	3,00	2,90	3,00	-	12	2,20	2,40	2,70	2,65	2,10	-
13	2,10	2,55	2,80	2,70	3,00	-	13	2,10	2,30	2,60	2,55	2,10	-
14	1,80	2,40	2,65	2,55	2,80	-	14	2,00	2,20	2,50	2,45	2,05	-
15	-	2,30	2,50	2,40	2,65	-	15	-	2,10	2,40	2,35	2,00	-
16	-	2,20	2,35	2,25	2,50	-	16	-	2,00	2,30	2,25	1,95	-
17	-	2,10	2,20	2,10	2,35	-	17	-	1,90	2,20	2,15	1,90	-
18	-	2,00	2,05	1,95	2,20	-	18	-	1,85	2,10	2,05	1,85	-
19	-	1,90	1,90	1,80	1,80	-	19	-	1,80	2,00	1,90	1,80	-
20	-	-	1,70	1,50	1,55	-	20	-	-	1,90	1,80	1,75	-
21	-	-	1,50	1,30	1,35	-	21	-	-	1,80	1,70	1,55	-
22	-	-	1,30	1,20	1,20	-	22	-	-	1,50	1,40	1,40	-
23	-	-	1,20	1,00	1,05	-	23	-	-	1,30	1,25	1,20	-
24	-	-	1,05	0,90	0,85	-	24	-	-	1,15	1,10	1,05	-
25	-	-	0,90	0,70	0,75	-	25	-	-	1,00	0,95	0,90	-
26	-	-	-	0,50	0,65	-	26	-	-	-	0,80	0,75	-
27	-	-	-	0,40	0,55	-	27	-	-	-	0,70	0,65	-
28	-	-	-	0,30	0,40	-	28	-	-	-	0,55	0,55	-
29	-	-	-	0,20	0,35	-	29	-	-	-	0,50	0,40	-
30	-	-	-	0,20	0,25	-	30	-	-	-	0,35	0,30	-
31	-	-	-	-	0,15	-	31	-	-	-	-	0,25	-
32	-	-	-	-	-	-	32	-	-	-	-	-	0,15
33	-	-	-	-	-	-	33	-	-	-	-	-	-

NOTES TO LIFTING CAPACITY · ANNOTAZIONI SULLE PORTATE

Weight of hook blocks and slings is considered part of the load and must be subtracted from the capacity ratings.

Consult operation manual for further details.

Note: Data published herein is intended as a guideline only and shall not be construed to warrant applicability for lifting purposes. For actual crane operation refer to the computer charts and the operating manual, both of which are supplied with the crane.

Il peso dei bozzelli e delle funi di imbracaggio viene considerato parte del carico e deve quindi essere sottratto dalle portate nominali.

Per ulteriori dettagli sulla velocità del vento, consultare il manuale di istruzione della gru.

Nota: I dati riportati in questo prospetto sono forniti esclusivamente a titolo indicativo, pertanto non sono da ritenersi impegnativi ai fini dell'applicazione della garanzia sulle portate di sollevamento.

Per l'uso della gru occorre rispettare le tabelle originali e il manuale d'uso forniti in dotazione con la gru stessa.

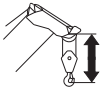
BOX TYPE JIB · PROLUNGA SCATOLATA





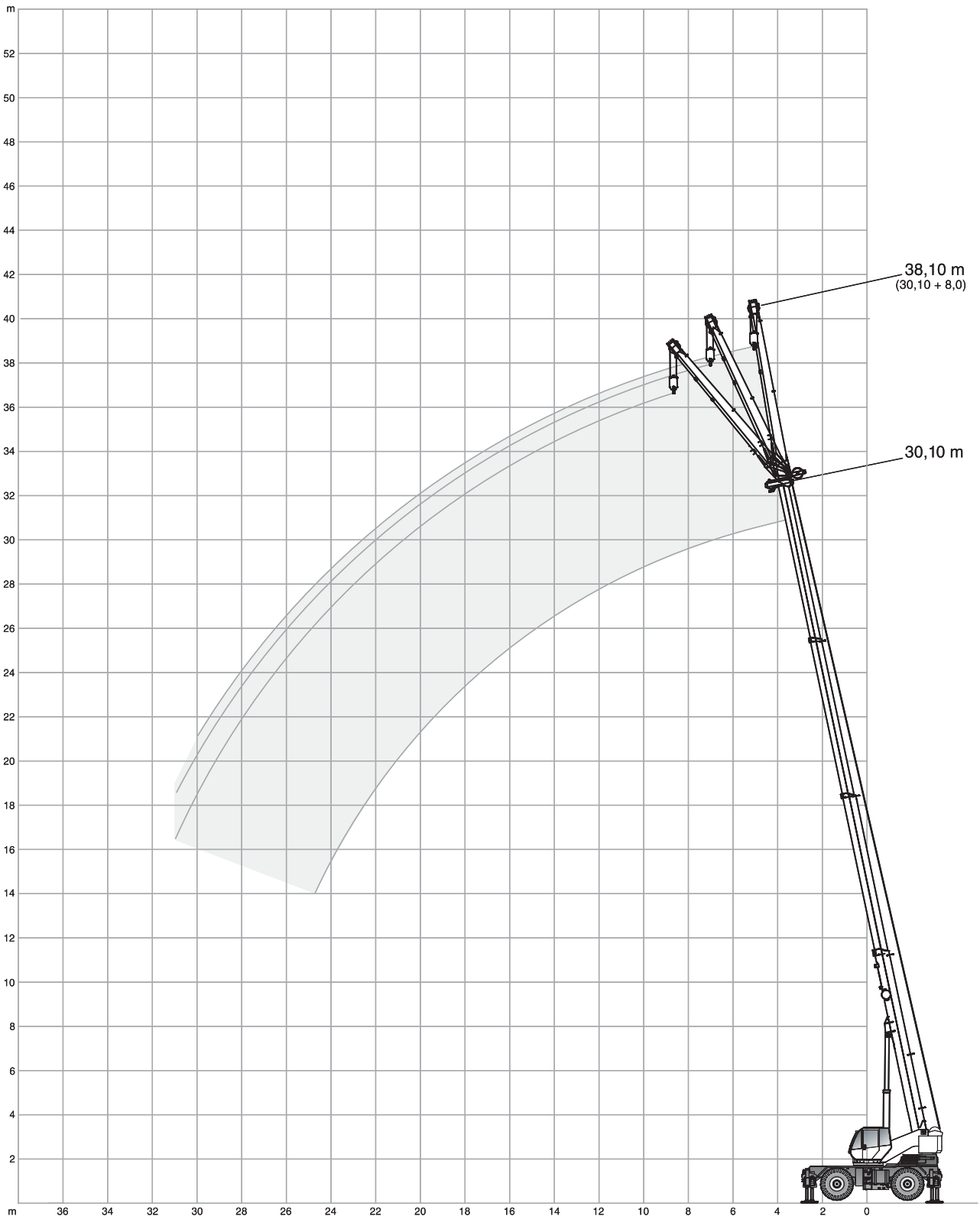



with hook ball: 0,7 m
with hook block: 1,6 m

con gancio a palla: 0,7 m
con bozzello: 1,6 m



BOX TYPE JIB · PROLUNGA SCATOLATA

5 t 5,6 m x 5,8 m 360° EU STANDARD EN 13000

8 m 0°							8 m 15°							8 m 30°																				
																																		
																																		
	9,1 m	14,4 m	19,6 m	24,9 m	30,1 m		9,1 m	14,4 m	19,6 m	24,9 m	30,1 m		9,1 m	14,4 m	19,6 m	24,9 m	30,1 m		9,1 m	14,4 m	19,6 m	24,9 m	30,1 m											
m	t	t	t	t	t	m	t	t	t	t	t	m	t	t	t	t	t	m	t	t	t	t	t											
3	5,40	5,20	-	-	-	3	5,40	-	-	-	-	3	-	-	-	-	-	3	-	-	-	-	-											
3,5	5,40	5,20	5,00	-	-	3,5	3,80	-	-	-	-	3,5	-	-	-	-	-	3,5	-	-	-	-	-											
4	5,10	5,20	5,00	-	-	4	3,60	-	-	-	-	4	-	-	-	-	-	4	-	-	-	-	-											
4,5	4,80	5,20	5,00	4,00	-	4,5	3,40	3,80	-	-	-	4,5	-	-	-	-	-	4,5	-	-	-	-	-											
5	4,40	5,20	5,00	4,00	-	5	3,20	3,55	-	-	-	5	3,10	-	-	-	-	5	3,10	-	-	-	-											
6	3,80	5,05	5,00	4,00	3,10	6	2,90	3,25	3,45	-	-	6	3,10	3,00	-	-	-	6	3,10	3,00	-	-	-											
7	3,30	4,55	4,90	4,00	3,10	7	2,60	3,00	3,25	3,40	-	7	3,10	3,00	2,90	-	-	7	3,10	3,00	2,90	-	-											
8	2,90	4,05	4,75	4,00	3,10	8	2,40	2,80	3,10	3,25	3,10	8	3,00	3,00	2,90	2,80	-	8	3,00	3,00	2,90	2,80	-											
9	2,60	3,55	4,30	4,00	3,10	9	2,20	2,60	2,95	3,10	3,10	9	2,90	3,00	2,90	2,80	2,60	9	2,90	3,00	2,90	2,80	2,60											
10	2,30	3,20	4,00	4,00	3,10	10	2,00	2,45	2,80	3,00	3,10	10	2,60	2,90	2,75	2,80	2,60	10	2,60	2,90	2,75	2,80	2,60											
11	2,10	2,90	3,70	3,90	3,10	11	1,90	2,30	2,70	2,90	2,90	11	2,40	2,70	2,65	2,80	2,60	11	2,40	2,70	2,65	2,80	2,60											
12	2,00	2,65	3,45	3,60	3,10	12	1,80	2,15	2,55	2,80	2,70	12	2,20	2,55	2,55	2,80	2,55	12	2,20	2,55	2,55	2,80	2,55											
13	1,80	2,40	3,10	3,30	2,90	13	1,70	2,05	2,40	2,70	2,60	13	2,00	2,45	2,40	2,70	2,45	13	2,00	2,45	2,40	2,70	2,45											
14	1,70	2,25	2,90	3,05	2,70	14	1,60	1,95	2,25	2,55	2,40	14	-	2,35	2,30	2,55	2,35	14	-	2,35	2,30	2,55	2,35											
15	-	2,10	2,70	2,90	2,60	15	-	1,85	2,15	2,45	2,30	15	-	2,20	2,20	2,40	2,25	15	-	2,20	2,20	2,40	2,25											
16	-	2,00	2,55	2,60	2,40	16	-	1,80	2,00	2,30	2,20	16	-	2,10	2,05	2,30	2,15	16	-	2,10	2,05	2,30	2,15											
17	-	1,85	2,40	2,30	2,30	17	-	1,70	1,90	2,20	2,10	17	-	2,00	1,95	2,15	2,05	17	-	2,00	1,95	2,15	2,05											
18	-	1,75	2,25	2,05	2,10	18	-	1,60	1,85	2,10	2,00	18	-	1,90	1,85	2,05	1,95	18	-	1,90	1,85	2,05	1,95											
19	-	1,65	2,10	1,80	1,70	19	-	1,55	1,80	2,00	1,90	19	-	-	1,75	1,95	1,85	19	-	-	1,75	1,95	1,85											
20	-	-	1,70	1,55	1,50	20	-	-	1,70	1,75	1,70	20	-	-	1,70	1,85	1,75	20	-	-	1,70	1,85	1,75											
21	-	-	1,50	1,35	1,30	21	-	-	1,60	1,50	1,40	21	-	-	1,60	1,60	1,65	21	-	-	1,60	1,60	1,65											
22	-	-	1,35	1,20	1,10	22	-	-	1,40	1,30	1,20	22	-	-	1,40	1,40	1,35	22	-	-	1,40	1,40	1,35											
23	-	-	1,20	1,05	0,90	23	-	-	1,30	1,10	1,10	23	-	-	1,15	1,20	1,15	23	-	-	1,15	1,20	1,15											
24	-	-	1,00	0,90	0,80	24	-	-	1,05	1,95	0,90	24	-	-	-	1,00	1,00	24	-	-	-	1,00	1,00											
25	-	-	0,90	0,75	0,70	25	-	-	-	1,80	0,80	25	-	-	-	0,85	0,85	25	-	-	-	0,85	0,85											
26	-	-	-	0,65	0,50	26	-	-	-	0,70	0,60	26	-	-	-	0,75	0,70	26	-	-	-	0,75	0,70											
27	-	-	-	0,50	0,40	27	-	-	-	0,60	0,50	27	-	-	-	0,60	0,60	27	-	-	-	0,60	0,60											
28	-	-	-	0,40	0,30	28	-	-	-	0,45	0,40	28	-	-	-	0,50	0,45	28	-	-	-	0,50	0,45											
29	-	-	-	0,30	0,20	29	-	-	-	0,35	0,30	29	-	-	-	0,35	0,35	29	-	-	-	0,35	0,35											
30	-	-	-	0,25	0,10	30	-	-	-	0,30	0,20	30	-	-	-	-	0,25	30	-	-	-	-	0,25											
31	-	-	-	-	-	31	-	-	-	-	0,10	31	-	-	-	-	0,15	31	-	-	-	-	0,15											

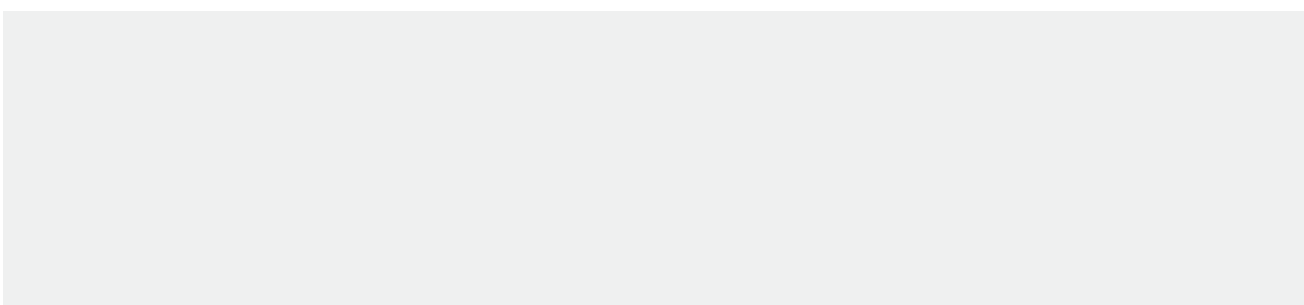

NOTES TO LIFTING CAPACITY · ANNOTAZIONI SULLE PORTATE

Weight of hook blocks and slings is considered part of the load and must be subtracted from the capacity ratings.

Consult operation manual for further details.

Note: Data published herein is intended as a guideline only and shall not be construed to warrant applicability for lifting purposes. For actual crane operation refer to the computer charts and the operating manual, both of which are supplied with the crane.

Il peso dei bozzelli e delle funi di imbracaggio viene considerato parte del carico e deve quindi essere sottratto dalle portate nominali.

Per ulteriori dettagli sulla velocità del vento, consultare il manuale di istruzione della gru.

Nota: I dati riportati in questo prospetto sono forniti esclusivamente a titolo indicativo, pertanto non sono da ritenersi impegnativi ai fini dell'applicazione della garanzia sulle portate di sollevamento.

Per l'uso della gru occorre rispettare le tabelle originali e il manuale d'uso forniti in dotazione con la gru stessa.



5 t 360° 0 km/h EU STANDARD EN 13 000

	9,1 m	14,4 m	19,6 m	24,9 m	
m	t	t	t	t	m
3	11,90	-	-	-	3
3,5	10,25	-	-	-	3,5
4	8,95	-	-	-	4
4,5	7,90	7,95	-	-	4,5
5	6,75	6,85	-	-	5
6	4,90	5,00	-	-	6
7	-	3,80	3,85	-	7
8	-	2,90	2,95	-	8
9	-	2,30	2,35	2,35	9
10	-	1,80	1,80	1,85	10
11	-	1,40	1,40	1,45	11
12	-	-	1,05	1,10	12
13	-	-	0,80	0,80	13
14	-	-	0,55	0,60	14
15	-	-	0,35	0,40	15
16	-	-	0,20	0,20	16
17	-	-	-	0,10	17

5 t 0° max. 2 km/h EU STANDARD EN 13 000

	9.1 m	14.4 m	19.6 m	
m	t	t	t	m
3	11,95	12,00	12,05	3
3,5	10,55	10,60	10,60	3,5
4	9,40	9,45	9,45	4
4,5	8,40	8,45	8,50	4,5
5	7,60	7,65	7,65	5
6	6,25	6,30	6,35	6
7	-	5,30	5,30	7
8	-	4,35	4,40	8
9	-	3,50	3,55	9
10	-	2,85	2,85	10
11	-	2,30	2,35	11
12	-	-	1,90	12
13	-	-	1,55	13
14	-	-	1,25	14
15	-	-	1,00	15
16	-	-	0,75	16
17	-	-	0,60	17

NOTES TO LIFTING CAPACITY · ANNOTAZIONI SULLE PORTATE

Weight of hook blocks and slings is considered part of the load and must be subtracted from the capacity ratings.

Consult operation manual for further details.

Note: Data published herein is intended as a guideline only and shall not be construed to warrant applicability for lifting purposes. For actual crane operation refer to the computer charts and the operating manual, both of which are supplied with the crane.





Il peso dei bozzelli e delle funi di imbracaggio viene considerato parte del carico e deve quindi essere sottratto dalle portate nominali.

Per ulteriori dettagli sulla velocità del vento, consultare il manuale di istruzione della gru.







Nota: I dati riportati in questo prospetto sono forniti esclusivamente a titolo indicativo, pertanto non sono da ritenersi impegnativi ai fini dell'applicazione della garanzia sulle portate di sollevamento.

Per l'uso della gru occorre rispettare le tabelle originali e il manuale d'uso forniti in dotazione con la gru stessa.







TECHNICAL DESCRIPTION · DESCRIZIONE TECNICA
BOOM · BRACCIO
Standard configuration · Configurazione standard:

	4 sections full power · 4 sezioni ad attuazione idraulica	
	Fully synchronized · Completamente sincronizzato	
	Min. / Max. · Min. / Max.	9.1 m / 30.1 m
	Max. tip height main boom · Altezza max. testa braccio principale	32.8 m
	Boom elevation angle range (min. / max.) · Angolo di brandeggio (min. / max.) Boom raising / lowering time · Tempo di sollevamento / abbassamento braccio Boom extension / retraction time · Tempo di estensione / retrazione del braccio	-2° / +78° 77 s / 67 s 92 s / 40 s





Optional · Opzionale:

















	Single sheave · Puleggia singola Max. tip height · Altezza max. testa braccio	33.5 m
	Lattice type jib, side stow · Tralicciata, staffabile lateralmente Angular offsets · Inclinazioni	8 m 0° / 20°
	Box type jib, side stow · Scatolata, staffabile lateralmente Angular offsets · Inclinazioni	8 m 0° / 15° / 30°
	Max. with 8 m lattice type jib · Max. con estensione tralicciata 8 m	38.1 m
	Max. with 8 m box type jib · Max. con estensione scatolata 8 m	38.1 m
	Max. with 8 m lattice type jib · Max. con estensione tralicciata 8 m	40.5 m
	Max. with 8 m box type jib · Max. con estensione scatolata 8 m	40.5 m

WINCH, ROPE AND HOOK · ARGANO, FUNE E GANCIO
Standard configuration · Configurazione standard:

	Two speeds (Hi / low range) · Due rapporti di velocità (alta / bassa) Smooth drum · Tamburo liscio Storage capacity · Capacità di avvolgimento fune	191 m
	Maximum without load – Hi-range in 5 th layer – · Massima senza carico – rapporto velocità alta al 5° strato Minimum without load – Low-range in 1 st layer – · Minimo senza carico – rapporto velocità bassa al 1° strato	1.75 m/s 0.92 m/s
	FAZ A6 Right hand lang lay · Avvolgimento parallelo destro FAZ A6	
		15 mm
		175 m
	Minimum breaking strength · Resistenza alla rottura minima Maximum permissible line pull · Tiro massimo ammissibile	196.3 kN 38.0 kN
	4 metallic sheaves: rated load · 4 pulegge in metallo: carico nominale	30 t

Optional · Opzionale:

	Hook ball: rated load · Gancio a palla: carico nominale	5 t
	1 sheave, one or two line pull: rated load · 1 puleggia, tiro singolo o doppio: carico nominale	10 t
	2 sheaves (for main winch only): rated load · 2 pulegge (solo per argano principale): carico nominale	15 t
	2 sheaves (for main winch only): rated load · 2 pulegge (solo per argano principale): carico nominale	20 t
	3 sheaves (for main winch only): rated load · 3 pulegge (solo per argano principale): carico nominale	25 t

TECHNICAL DESCRIPTION · DESCRIZIONE TECNICA	
	Two speeds · Due velocità Smooth drum · Tamburo liscio Storage capacity · Capacità di avvolgimento fune 191 m
	Maximum single line without load – 5 th layer, Hi-range · Massima in tiro diretto senza carico – rapporto velocità alta 5° strato 1.75 m/s
	FAZ A6 Right hand lang lay · Avvolgimento parallelo destro FAZ A6
	15 mm
	150 m
	Minimum breaking strength · Resistenza alla rottura minima 196.3 kN Maximum permissible line pull · Tiro massimo ammissibile 38.0 kN
SUPERSTRUCTURE · SOVRASTRUTTURA	
Standard configuration · Configurazione standard:	
	5 t
	Non stop · Senza fine 360° Maximum speed without load · Velocità massima senza carico 2 rpm
	Hydraulic motor · Motore idraulico Planetary reducer · Riduttore epicicloidale
	Automatically actuated, possible manual release · Inserimento automatico, con possibilità di rilascio manuale
	Lock-pin at 0° (boom straight over front) · Perno di bloccaggio a 0° (braccio sul davanti)
CAB, CONTROLS AND SAFETY DEVICES · CABINA, COMANDI ED EQUIPAGGIAMENTO DI SICUREZZA	
Standard configuration · Configurazione standard:	
	Sliding door · Porta scorrevole Tilting skylight glass hinged tinted · Vetro superiore oscurato con apertura a ribalta Six ways adjustable seat · Sedile regolabile a sei movimenti
	Armrest mounted dual axis hydraulic joysticks · Joystick idraulici a due assi montati su bracciolo On joystick: controls for winches, slewing, boom elevation, boom telescoping, slewing brake · Sui joystick: Comandi argani, rotazione, sollevamento braccio, sfilamento braccio, freno rotazione Foot pedals for engine throttle and service brake · Comandi a pedale per freno di servizio Steering wheel column · Piantone sterzo Dashboard mounted switches for steering mode, outriggers and engine control · Comandi a cruscotto per la modalità di sterzata, gli stabilizzatori e il controllo motore
	Electronic load indicator and limiter with graphic interface · Indicatore e limitatore di carico elettronico con interfaccia grafica
	Diesel heater and defroster · Riscaldatore e sbrinatori a gasolio
Optional · Opzionale:	
	Air-conditioning · Aria condizionata
	Outrigger ground control from on both parts of the carrier · Comando a terra per stabilizzatori su entrambi i lati del carro Slewing range control · Comando intervallo di rotazione

TECHNICAL DESCRIPTION · DESCRIZIONE TECNICA
CARRIER, ENGINE, DRIVE-LINE AND HYDRAULIC · CARRO, MOTORE, TRASMISSIONE E SISTEMA IDRAULICO
Standard configuration · Configurazione standard:

	Hydraulic independent · Idraulica indipendente:	
	Outrigger footprint area 100 % extended · Area di stabilizzazione – apertura 100 %	32.6 m ²
	Outrigger footprint area 50 % extended · Area di stabilizzazione – apertura 50 %	18.1 m ²
	Outrigger footprint area 0 % extended · Area di stabilizzazione – apertura 0 %	12.9 m ²
	Diameter of outrigger pads (area) · Diametro piastre di appoggio stabilizzatori (area)	52.5 cm (2164 cm ²)
	Single outrigger jack extending and retracting time · Tempo di apertura e chiusura singolo stabilizzatore	10 s
	Single outrigger beam extending and retracting time · Tempo di apertura e chiusura singolo traversa porta-stabilizzatori	4 s

	Cummins QSB4.5 4 cylinders · Cummins QSB4.5 4 cilindri	
	Rated power · Potenza nominale	104 kW @ 2000 1/min.
	Maximum gross torque · Coppia massima	504 Nm @ 1800 1/min.
	Intake: turbocharged with intercooler · Aspirazione: turbocompressore con intercooler	
	Fuel type · Tipo di carburante	Diesel
	Fuel tank capacity · Capacità serbatoio carburante	240 l

	6 x 6 powershift with torque converter · Powershift 6 x 6 con convertitore di coppia	
	4WD if traveling in Lo-range · 4 ruote motrici con gamma velocità lente inserita	
	Rigid mounted front axle · Assale anteriore rigido	
	Oscillating mounted rear axle · Assale posteriore oscillante	
	Automatic rear axle oscillation lock when superstructure is slewed 3° from centerline in either direction · Blocco automatico dell'oscillazione dell'assale posteriore quando la torretta è ruotata di 3° rispetto all'asse longitudinale centrale in qualsiasi direzione	
	Air over hydraulic service brake system · Freno di servizio pneumatico idraulico	
	Parking brake on front axle · Freno di stazionamento su assale anteriore	

	3 modes hydraulic power steering · Servosterzo idraulico a 3 modalità	
	Front wheels mode – minimum steering curb clearance radius · Modalità a 2 ruote anteriori – raggio minimo di sterzata all'esterno dei pneumatici	13.2 m
	All wheels concentric steering mode – minimum steering curb clearance radius · Modalità a 4 ruote concentriche – raggio minimo di sterzata all'esterno dei pneumatici	
	All wheels crab steering mode · Modalità sterzata a granchio (tutte le ruote)	

	Double gear pump for main and auxiliary winch, stabilizers and slewing · Pompa doppia ad ingranaggi per argano principale ed ausiliario, stabilizzatori e rotazione	
	Double gear pump for boom hoisting, boom telescoping and steering · Pompa doppia ad ingranaggi per sollevamento braccio, allungamento braccio e sterzata	
	Hydraulic oil tank capacity · Capacità serbatoio olio idraulico	390 l
	Hydraulic oil filters · Filtri olio idraulico	25 µm

Optional · Opzionale:

	Heater for engine cooling system · Riscaldatore per liquidi di raffreddamento del motore	
---	--	--

	Rear axle differential lock · Blocco differenziale assale posteriore	
	Front axle differential lock · Blocco differenziale assale anteriore	

VEHICLE PERFORMANCE · PRESTAZIONI DEL VEICOLO
Standard configuration · Configurazione standard:

	Max. in 1 st gear – standard tires · Max. in 1° marcia – pneumatici standard	98.3 %
	Max. in 6 th gear – standard tires · Max. in 6° marcia – pneumatici standard	3.5 %

	Max. in 6 th gear – standard tires · Max. in 6° marcia – pneumatici standard	30 km/h
---	---	---------

	Min. / Max. operating temperature · Temperatura di esercizio min. / max.	-20° / 45 °C
---	--	--------------

Optional · Opzionale:

	Max. in 1 st gear – optional tires · Max. in 1° marcia – pneumatici opzionali	84.5 %
	Max. in 6 th gear – optional tires · Max. in 6° marcia – pneumatici opzionali	3.0 %

	Max. in 6 th gear – optional tires · Max. in 6° marcia – pneumatici opzionali	31 km/h
---	--	---------

TECHNICAL DESCRIPTION · DESCRIZIONE TECNICA
TIRES · PNEUMATICI
Standard configuration · Configurazione standard:

Wide earth moving style tread (E3) · Per movimento terra (E3)

14.00R24

Optional · Opzionale:

Wide earth moving style tread (E3) · Per movimento terra (E3)

16.00R25

OTHER OPTIONS · ALTRE OPZIONI

Emergency engine stop with spark arrestor

Arresto di emergenza del motore con parascintille

Rim for spare standard wheel

Cerchione per ruota di scorta standard

Rim for spare optional wheel

Cerchione per ruota di scorta opzionale

Rear towing hook

Gancio di traino posteriore

Spark arrestor on exhaust pipe muffler

Parascintille su marmitta

Radio with CD-player in cab

Radio con lettore CD in cabina

Safety belts for driver seat

Cinture di sicurezza per il sedile dell'operatore

Working light on the main boom element

Faro di lavoro sull'elemento principale del braccio

Working light on the upper structure

Faro di lavoro sulla torretta

Directional working light adjustable from inside the cab

Faro di lavoro direzionale regolabile dall'interno della cabina

Heat exchanger with by-pass valve instead of standard

Scambiatore di calore con valvola di bypass anziché standard

Anti-corrosive protective waxing

Rivestimento con cera protettiva anticorrosione

Shipping protection for cab (wooden case)

Cassa di spedizione in legno protettiva per la cabina

Removable parts dismantled and placed in wooden container for shipping

Parti rimovibili smontate e imballate in un contenitore in legno per la spedizione

Dismantling of removable parts for sea transport

Smontaggio delle parti rimovibili per le spedizioni via mare

Custom paint: Single color on complete crane

Vernice personalizzata: singolo colore sull'intera gru

Custom paint: Single color on lower part of crane only

Vernice personalizzata: Singolo colore solo sulla parte inferiore della gru

Custom paint: Two-color scheme on complete crane

Vernice personalizzata: Schema bicolore sull'intera gru

Heavy-duty painting suitable for corrosive environments

Verniciatura resistente per ambienti corrosivi

Custom paint of all boom elements

Vernice personalizzata su tutti gli elementi del braccio



Effective Date: January 2010. Product specifications and prices are subject to change without notice or obligation. The photographs and/or drawings in this document are for illustrative purposes only. Refer to the appropriate Operator's Manual for instructions on the proper use of this equipment. Failure to follow the appropriate Operator's Manual when using our equipment or to otherwise act irresponsibly may result in serious injury or death. The only warranty applicable to our equipment is the standard written warranty applicable to the particular product and sale and Terex makes no other warranty, express or implied. Products and services listed may be trademarks, service marks or trade-names of Terex Corporation and/or its subsidiaries in the USA and other countries. All rights are reserved. Terex® is a registered trademark of Terex Corporation in the USA and many other countries.

Data di inizio validità: Gennaio 2010. Ci riserviamo il diritto di modificare le specifiche e i prezzi dei prodotti in ogni momento e senza preavviso. Le fotografie e/o i disegni contenuti in questo documento sono destinati unicamente a scopi illustrativi. Consultare le istruzioni sull'uso corretto di questo macchinario, contenute nell'opportuno Manuale dell'operatore. L'inottemperanza delle istruzioni contenute nel Manuale dell'operatore del macchinario e altri comportamenti irresponsabili possono provocare gravi lesioni, anche mortali. L'unica garanzia applicabile ai nostri macchinari è la garanzia scritta standard applicabile al particolare prodotto e alla particolare vendita; Terex è esonerata dal fornire qualsiasi altra garanzia, esplicita o implicita. I prodotti e servizi elencati possono essere dei marchi di fabbrica, marchi di servizio o nomi commerciali di TEREX Corporation e/o società affiliate negli Stati Uniti d'America e altre nazioni e tutti i diritti sono riservati. „TEREX“ è un marchio registrato di Terex Corporation negli USA e molti altri Paesi.